

The Robot Builder

Volume Eleven Number Five

May 1999

Notices

- Introductory Mobile Robotics Class - 10:00AM - 12:00PM
- Business Meeting - 12:30 - 1:00
- General Meeting - 1:00 - 3:00

Distribution

If you would like to receive The Robot Builder via e-mail, contact the editor at:

apendrag@earthlink.net

Inside this Issue

W. Grey Walter and his Turtle Robots..... 1

OPTICAL DISTANCE SENSOR for ROBOTS... 3

MIT's New 6.270 Robot Board..... 6

W. Grey Walter and his Turtle Robots

by Arthur Ed LeBouthillier

Simple robots based on animal-like neural systems and behaviors may seem like a novelty today, but they have their genesis in the work of one of the early pioneers of robotics and artificial life, W. Grey Walter. W. Grey Walter developed a number of robots in the 1940's and 1950's which demonstrated great sophistication for their day. The technique he used are reflected in today's reactive and biologically-inspired robots such as those based on the B.E.A.M philosophy.

Born in Kansas City, Missouri in 1910, William Grey Walter later moved to England where he got his education and started a career as a neurophysiologist. As part of this endeavor, he studied the operation of the brain in-depth through the

instrument which he had developed into a practical tool, the Electroencephalogram (EEG). In using this instruments, H. Grey Walter was responsible for identifying the brain waves known as Alpha, Delta and Theta waves.

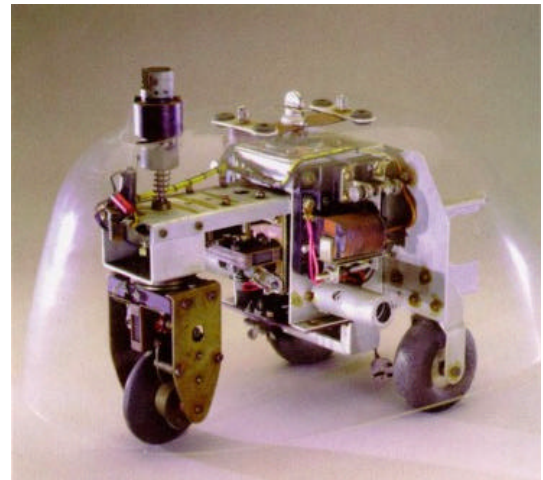

Figure 2 - Machina Speculatrix



Figure 1 - W. Grey Walter and one of his robots

Walter's Robots

In order to better understand the operation of animal brains, Mr. Walter proposed building simple models of their basic operations. In 1948 and 1949, Mr. Walter built two robots to demonstrate his theories of nervous systems. Named Elmer and Elsie (short for ELeCTro MEchanical Robots, Light Sensitive), Walter's robots were simple front wheel drive tricycle-like robots covered by a clear plastic shell. These first robots were rather crude prototypes but his technician later built better quality robots on his design which were widely shown in public. These robots represented some of the first examples of autonomous robots.

Editorial

May 1999

Is there an ARM Processor in your future?

M.I.T.'s 6.270 class has motivated a whole generation of robotics hobbyists with Lego and 68HC11 based robots. Using boards which eventually inspired the commercial Handy Board, the advanced engineering class posed difficult problems which required original solutions. Consequently, many robotics hobbyists learned their skills on machines inspired by tools developed for the class. Although the 68HC11 is, rightfully, a popular processor among hobby roboticists, it shows many weaknesses because of the poor quality of cheap development tools available. Sure, Integrated C and other packages exist, but compared to some of the modern software development environments, they are archaic.

Now, MIT's 6.270 class is using a RISC processor developed by Advanced RISC Machines (ARM) for its Lego robots. Built by Compaq computers and programmed in the Java language, it offers an exciting package for hobbyists. Hopefully, we'll see the commercial markets making similar machines available for the hobbyist market. Although there are neo-Luddites who ask "who needs more than 64K of RAM," as a programmer I know that it never hurts to have additional resources both in memory and in processing power. Additionally, the Java language offers a nice environment supporting modularity, multitasking and code re-use. Perhaps this will lead to hobbyist libraries eliminating the need to "reinvent the wheel" with each new robot project.

Arthur Ed LeBouthillier, Editor

From the simple neural circuitry, several sophisticated behaviors arose. Under normal operation, the steering motor turned slowly with the drive motor at half speed. This scanned the photocell and produced an arcing motion.

When the photocell detected a bright-enough light, the turning stopped and the robot headed towards it. This demonstrated simple phototropic (light attracted) behavior. Once the light detected by the photocell became too bright, though, the steering motor began turning; this demonstrated photophobic (light avoiding) behavior. If the shell struck an object, then the system would oscillate until it successfully avoided the object.

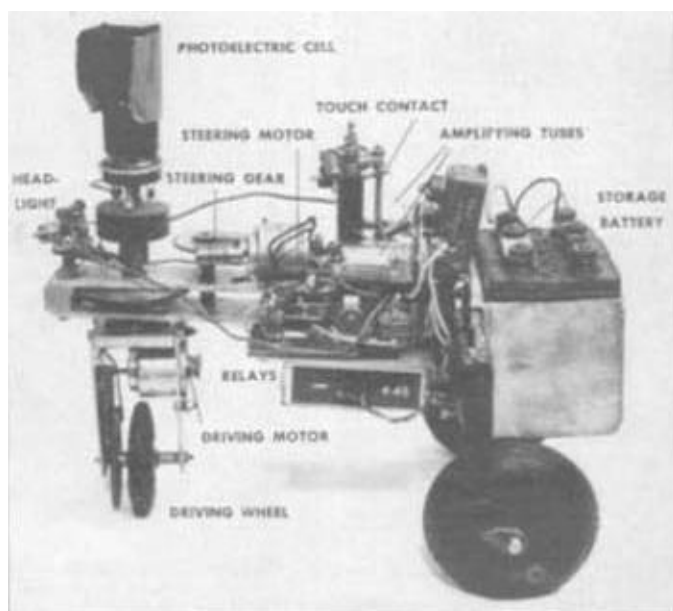

Figure 3 - A labeled photo of Elsie

Turtle from Page 1

Machine Speculatrix

Mr. Walter dubbed his first type of robot "*Machina Speculatrix*," because "it explores its environment actively, persistently, systematically as most animals do". The first robots each used one vacuum tube to simulate two interconnected neurons. These simple amplifier circuits connected two sensors to two motors. The first sensor was a photocell and it was connected to the drive and steering motors. The second sensor was a contact switch that indicated that the turtle's "shell" had bumped into something; this sent the vacuum-tube amplifiers into oscillation and changed the robot's direction. This circuitry allowed the turtles to wander a room and return to a hutch to recharge their batteries.

Machina Docilis

After building his first robots, Mr. Walter added additional capabilities naming his new robot, Machina Docilis. Based on the same physical design, these robots included a Conditioned Reflex Analogue (CORA) which demonstrated simple Pavlovian learning. The new robots had three sensors: a sound detector, the light detector and a bump switch. The CORA circuitry could be trained to establish learned connections between the three sensors and the motor drive oscillators. This resulted in an ability to learn different behaviors which were initiated by sounds, light or the bumpers. This kind of circuitry is structurally very

(see *Turtle* on page 3)

May 1999

Turtle from Page 2

similar to neural circuitry most recently identified in marine snails.

Robotist's Inspiration

W. Grey Walter's work has inspired generations of roboticists. Rodney Brooks, recent innovator of reactive robots, drew on Walter's work. As a child, Brooks had read Walter's book, The Living Brain, and built his own versions of the machines described in it. Even this author has to credit seeing pictures of Walter's robots as being a major motivator for his interest into robotics.

Conclusion

W. Grey Walter was a robotics pioneer who demonstrated early autonomous robots based on neural-like circuit designs. His robots demonstrated sophisticated emergent behaviors despite their very simple construction. His designs were responsible for motivating generations of robotics enthusiasts.

OPTICAL DISTANCE SENSOR for ROBOTS

by Jim Ubersetzig

Have you ever wanted to add sensors to your robot - but weren't sure how to do it ?

In this article I will show you how to build a distance measuring sensor for your robot. The sensor could be used by the robot to avoid running into walls or obstacles.

The optical proximity sensor described here uses light to measure the distance to the obstacle. The distance is reported as a number. A suggested arrangement is shown in figure 1.

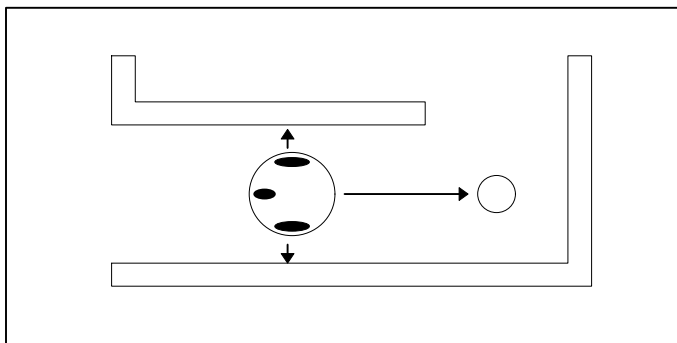

Figure 1 - Sensing walls and obstacles with optical sensors

Note that three sensors are mounted on the robot. If the robot were traveling down a corridor, the sensors would report distance from the walls, and also report distance to anything the robot is about to run into.

The distance is accurately reported from 4 inches to three feet. Distances beyond three feet are reported as three feet. The sensor is highly tolerant of room lighting (except sunlight) and is not affected by colors or reflectances of target objects.

Figure 2 shows two screw holes which are provided for mounting the sensor to the robot.

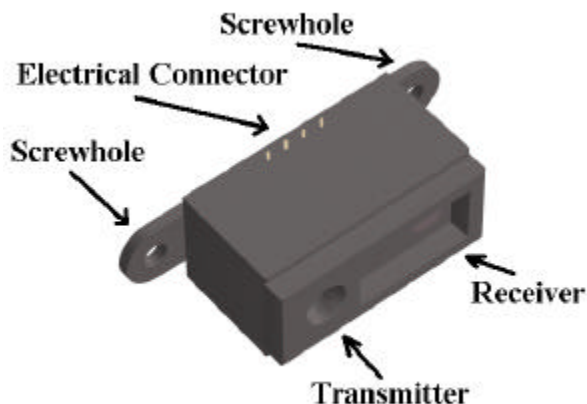

Figure 2 - GP2D02 Mounting Provisions

SOURCES

When the author purchased his Sharp GP2D02 sensors in Feb 98, there were few sources for the device. You could purchase the minimum order from a Sharp distributor (thousand units minimum

(see Sensor on page 4)

buy) or you could search for someone who has a few left over. The author purchased his sensors for \$75 each from someone on the internet.

Today the situation has changed. You can buy your GP2D02 sensors from HVW company for about \$40. They include the electrical connector.

HVW is at
www.hvwtech.com/robotics.htm#dirrs
Tel: (403) 730-8603
Fax: (403) 730-8903
Info@HVWTech.com

To use the software provided in this article, you will also need a Basic Stamp 2 computer (around \$50).

Note: To load the software in this article into the Basic Stamp, you need a PC. The stamp also uses the PC to display test results. If you use the remaining Basic Stamp pins to build a robot base to mount the sensor on, then the robot could operate without the PC.

Skills Required

You will need certain minimum skills to complete the device described in this article:

- Soldering, electronic grade.
- Cutting plastic sheet.
- Safety skills to avoid injuries.
- Drilling holes.

Theory of Operation

The Sharp distance sensor uses an infra red light-emitting-diode (IR LED) as a light source. The reflected light is brought through a lens which focuses the light into a tiny spot which strikes a position-sensitive detector (PSD).

The distance is determined by a principle called optical triangulation. This is shown in the figure 3. As the distance to the sensed object changes, the spot of light moves on the position-sensitive detector, and a different distance is reported.

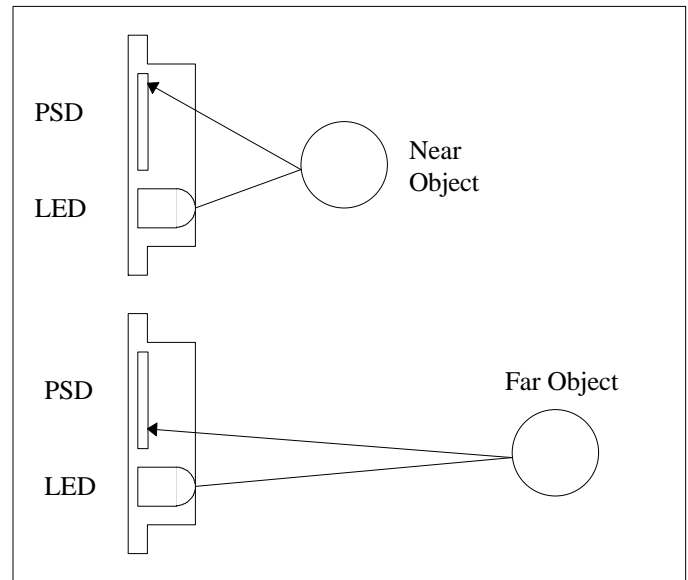

Figure 3 - Optical Triangulation for distance measurement

Wiring the Sensor

Wiring the sensor is easy, because HVW company includes the connector with your purchase. When making the electrical connections, you should include two resistors. If you leave them out, the sensor reading will be erratic. Connect the wires as per figure 4.

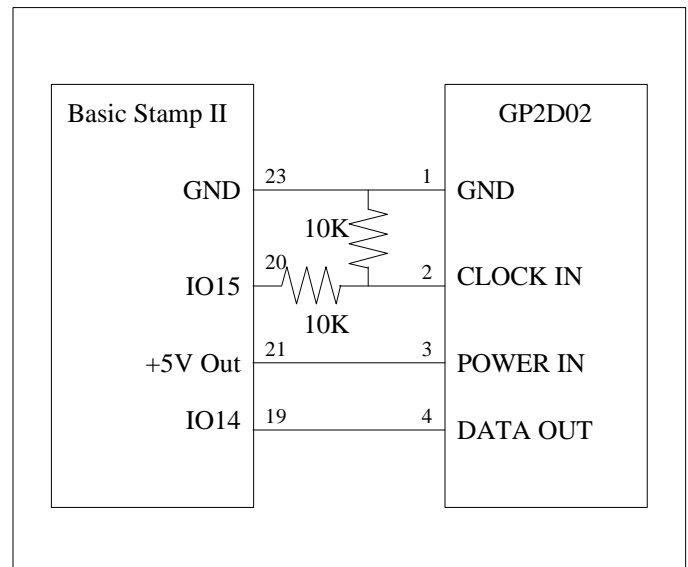

Figure 4 - Wiring the sensor

Software

```
'-----[ Title ]-----
'File..... GP2D02.BS2
'Purpose... Distance Sensor
'Author.... Jim Ubersetzig
'           juberset@lmco.com
'Written... 24 Sept 98

'-----[ General Description ]-----
' The Sharp GP2D02 distance measuring sensor measures distance using
' optical triangulation.
' This software is for using the sensor with a Basic Stamp 2 computer.

'-----[ Detailed Description ]-----
' The distance is reported as a number in the range 225 to 70, which
' corresponds to distances from 4 inches to 3 feet. Distances greater
' than 3 feet are reported as three feet.

'-----[ BS2-IC Wiring Connections ]-----
'
' pin 23      Ground                | pin 1
' pin 21      +5VDC out             | pin 3
' pin 20      IO15/Clock Out        | pin 2 Distance sensor
' pin 19      IO14/Data In          | pin 4 type gp2d02

' Note: The sensor performs best if two 10K resistors are used. Connect one
' 10K resistor from pin 20 to pin 2. The other 10K resistor goes from
' pin 2 to ground.

'-----[ Constants ]-----
'
PinClock    CON        15
PinData     CON        14

'-----[ Variables ]-----
'
alpha       VAR        word        ' Sensor reading, approx 75 for 31 inches,
                                   ' 135 for 8 inches.

'-----[ Main Code ]-----
'
INPUT      PinData          ' Initialize the electronics.
HIGH      PinClock
PAUSE     500

MainLoop:
GOSUB    ReadTheSensor
pause    1000                ' Display sensor information for one
second.
GOTO     MainLoop           ' Then read the sensor again.

ReadTheSensor:
LOW      PinClock          ' Start process by driving the clock low for 70 mS.
PAUSE    70
SHIFTLN  PinData,PinClock,msbpost,[alpha] ' Then shift in the data.
HIGH     PinClock          ' and set the
clock high.
PAUSE    2
debug    dec ? alpha       ' Display sensor reading on a pc.
RETURN

'-----[ End of Software ]-----
```

Get It Working ?

On your PC type stamp2 <enter> and the stamp development system will come up. If you don't have this file (stamp2.exe approx 15K bytes), it's a free download from the parallax web site. It also comes with the developer's kit, along with the cable.

If you don't have the cable, instructions for building one are on the web site.

enough !

On your PC you should see a blue screen. Type in the software, then ALT-S to save the software in a file. Type in a suitable file name, then <enter>. Now ALT-Q to exit. The software is saved on your PC.

To operate the sonar sensor: On the PC type:

stamp <enter>

You'll see the blue screen again. ALT-L will let you select the software you have previously saved. Once you see the software on the PC display, hook up the cable from your PC's com port to the stamp.

Now ALT-R will start the software running. You should see a list of numbers on the computer screen. These are the distance numbers reported by the sensor. Place an object where the sensor should see it and the numbers should change. Experiment with different objects and different distances. The distance numbers reported should be used with the chart in figure 5.

The Future ?

The author encourages experimentation. After building the project, try changing something. You might find an improvement !

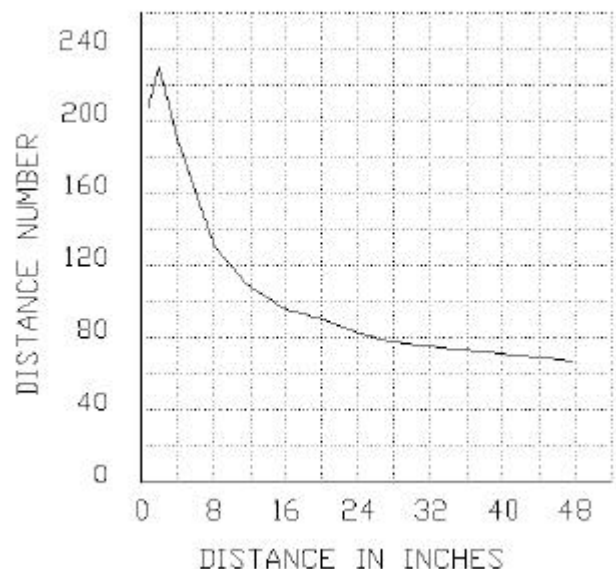

May 1999

MIT's New 6.270 Robot Board

by Arthur Ed LeBouthillier

Massachusetts's Institute of Technology's (MIT) engineering department has been famous for their annual robot competition. Developed out of a desire to challenge engineering students, the 6.270 class dares the students to go beyond mere book learning by doing rather than watching. This class requires engineering students to compete against their fellow students by designing small robots to do specific tasks.

In conjunction with their class, a 68HC11-based processor board was developed which inspired a generation of robot builders. From it, numerous commercial products were developed to help hobbyists build small robots; the Handy Board is one example of this. The 68HC11-based Handy-board and other similar boards represent the processing board of choice for many of today's robotics hobbyists. However, MIT's 6.270 has moved beyond the 68HC11-based boards and has now moved on to a new processor board based on a much more powerful RISC processor developed by ARM, Inc.

Skiff

Dubbed "Skiff" by the board's manufacturer, the Compaq computer company, the 3.4" X 5.1" board is based on an Intel-built Strong-ARM SA110 CPU. It has 4 Megabytes of flash memory for permanent program storage and 16 Megabytes of RAM; it can support clock speeds from 88 to 287 MHz. It runs a variation of Unix called NetBSD as the operating system and has a Java runtime environment which allows you to develop software development on your favorite computer. The board has an optional USB interface and advanced power management features. It is designed to be run directly from a 6 Volt battery.

Built to be used in conjunction with the main processor board, is a Robot Controller Card which features a wide variety of output drivers and sensor interfaces.

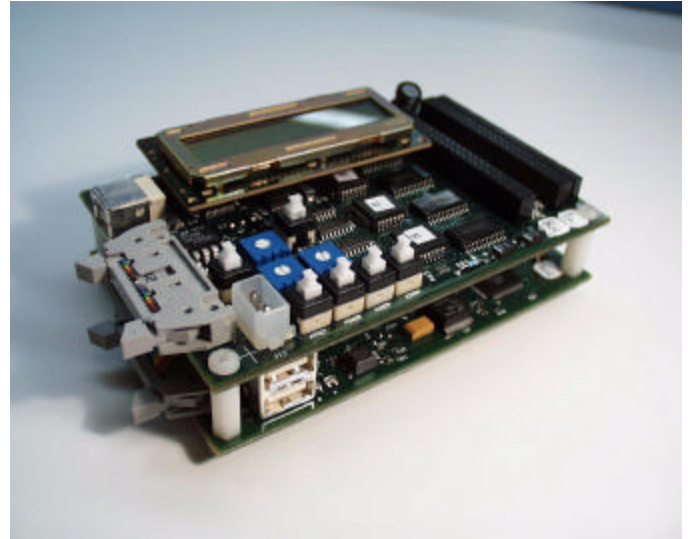

The amazing array of hardware input and output capabilities include:

- 20 motor drivers
- 5 servo drivers
- 32 Analog-to-Digital ports
- 6 buttons (4 connected to A2Ds, 2 for resets)
- 3 pots (2 connected to A2Ds, 1 for LCD)
- LCD connector

Like any Unix operating system the free, public-domain NetBSD OS provided with the board gives support for multi-tasking capabilities, numerous RAM disks, and is compatible with a tremendous array of public domain software. As is standard with the object-oriented Java programming language, there is support for multi-threading as well as compatibility with the whole public-domain software base that supports it.

The Skiff board represents a tremendous processing package for robotics hobbyists. As representative of the next generation of embedded controllers for robots, it offers exciting possibilities.

Robotics Society of Southern California

President Randy Eubanks
Vice President Henry Arnold
Secretary Arthur Ed LeBouthillier
Treasurer Tom Thornton
Past President Jess Jackson
Member-at-Large Tom Carrol
Member-at-Large Pete Cresswell
Member-at-Large Jerry Burton
Faire Coordinator Joe McCord
Newsletter Editor Arthur Ed LeBouthillier

The Robot Builder (TRB) is published monthly by the Robotics Society of Southern California. Membership in the Society is \$20.00 per annum and includes a subscription to this newsletter.

Membership applications should be directed to:

Robotics Society of Southern California
Post Office Box 26044
Santa Ana, CA 92799-6044

Manuscripts, drawings and other materials submitted for publication that are to be returned must be accompanied by a stamped, self-addressed envelope or container. However, RSSC is not responsible for unsolicited material.

We accept a wide variety of electronic formats but if you are not sure, submit material in ascii or on paper. Electronic copy should be sent to:

apendrag@earthlink.net

Arthur Ed LeBouthillier - editor

The Robotics Society of Southern California was founded in 1989 as a non-profit experimental robotics group. The goal was to establish a cooperative association among related industries, educational institutions, professionals and particularly robot enthusiasts. Membership in the society is open to all with an interest in this exciting field.

The primary goal of the society is to promote public awareness of the field of experimental robotics and encourage the development of personal and home based robots.

We meet the 2nd Saturday of each month at California State University at Fullerton in the electrical engineering building room EE321, from 12:30 until 3:00.

The RSSC publishes this monthly newsletter, The Robot Builder, that discusses various Society activities, robot construction projects, and other information of interest to its members.

Membership/Renewal Application

Name _____

Address _____

City _____

Home Phone () - Work Phone () -

Annual Membership Dues: (\$20) Check #
(includes subscription to The Robot Builder)

Return to: RSSC
 POB 26044
 Santa Ana CA 92799-6044

How did you hear about RSSC? _____

RSSC
POB 26044
Santa Ana CA 92799-6044

Please check your address label to be sure your subscription will not expire!